

wall
230-275

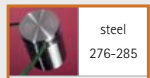

steel
276-285

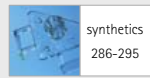

synthetics
286-295

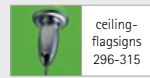

ceiling-
flagsigns
296-315

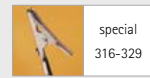

special
316-329

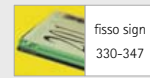

fiiso sign
330-347

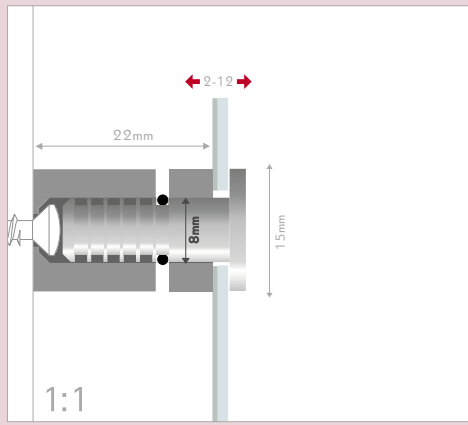

FISSO
safe

IT sistema variabile zigrinato, chiusura di sicurezza, veloce da montare. inserire le testine nel pannello e le rondelle in pvc, montare i distanziali alla parete. premere il pannello con le testine nei fori dei distanziali. inserire la moletta. **fissaggio:** sistema zigrinato, con chiusura laterale di sicurezza. **materiale:** acciaio inox o ottone color cromo lucido o argento satinato. **distanza dalla parete:** 22mm. **spess. del pannello:** max 12mm

DE variables raster-klemmsystem, manipulationsgeschützt, schnell. köpfe durch paneel und pvc-scheibe stecken, hülsen wandmontieren. köpfe einfach aufklicken. metallklemme einschieben. **befestigung:** raster-klemmsystem, manipulationsicher. **materiale:** edelstahl bzw. messing versilbert oder verchromt. **wandabstand:** 22mm. **plattenstärke:** bis max.12mm.

EN variable grid-clampsystem, tamper-proof, quickly mounted. put the head through panel and washer, wallmount the spacers. plug the heads into the spacers and insert the spring. **mounting:** variable grid-clampsystem, tamper-proof. **materiale:** stainless steel or brass, silver- or chrome-plated. **wall distance:** 22mm. **sign thickness:** max. 12mm.

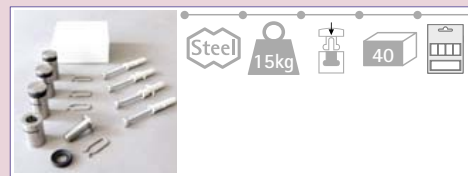

n° articolo | artikelnr. | product nr.
acciaio | stahl | steel 1box pz/st/pc
FSF1520IX 015mm 40pc

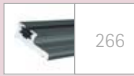

266



196



264



273

combinazioni | kombinationen | combinations

fiiso

acciaio | stahl | steel